

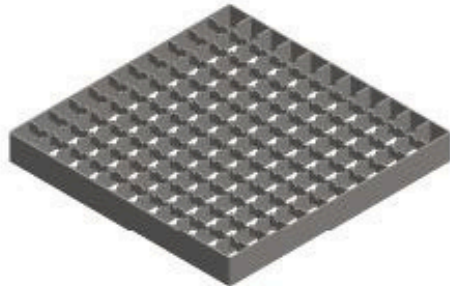

**PAVING A WAY INTO THE
FUTURE OF DRAINAGE**
www.sribal.in

PRODUCT CATALOGUE

HYGIENIC DRAINAGE SYSTEM



GRATING



SILT BASKET



FOUL AIR TRAP (FAT)



HYGIENIC GULLY

STANDALONE SQUARE

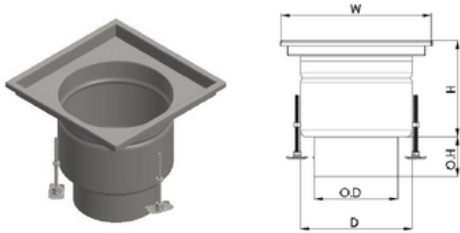

TYPE NO	PART NO	FAT	MOC	W	D	O.D	H	O.H
11286400	SBFT1101	WITH FAT	SS304	200x200	155	75	170	80
	SBFT1102	WITHOUT FAT	SS316L					
	SBFT1103	WITH FAT	SS304	200x200	155	93	170	80
	SBFT1104	WITHOUT FAT	SS316L					
11286401	SBFT1105	WITH FAT	SS304	250x250	155	75	170	80
	SBFT1106	WITHOUT FAT	SS316L					
	SBFT1107	WITH FAT	SS304	250x250	155	93	170	80
	SBFT1108	WITHOUT FAT	SS316L					
11286402	SBFT1109	WITH FAT	SS304	300x300	222	93	190	80
	SBFT1110	WITHOUT FAT	SS316L					
	SBFT1111	WITH FAT	SS304	300x300	222	135	190	100
	SBFT1112	WITHOUT FAT	SS316L					
	SBFT1113	WITH FAT	SS304	300x300	222	160	190	100
	SBFT1114	WITHOUT FAT	SS316L					

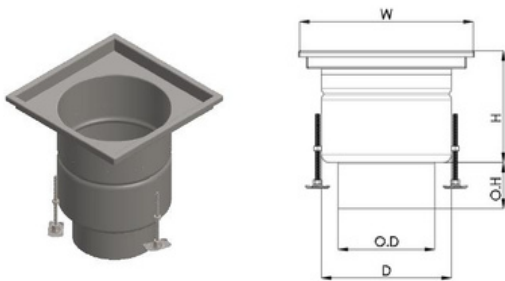

TYPE NO	PART NO	FAT	MOC	W	D	O.D	H	O.H
11286403	SBFT1115	WITH FAT	SS304	200x200	155	75	230	80
	SBFT1116	WITHOUT FAT	SS316L					
	SBFT1117	WITH FAT	SS304	200x200	155	93	230	80
	SBFT1118	WITHOUT FAT	SS316L					
11286404	SBFT1119	WITH FAT	SS304	250x250	155	75	230	80
	SBFT1120	WITHOUT FAT	SS316L					
	SBFT1121	WITH FAT	SS304	250x250	155	93	230	80
	SBFT1122	WITHOUT FAT	SS316L					
11286405	SBFT1123	WITH FAT	SS304	300x300	222	93	250	80
	SBFT1124	WITHOUT FAT	SS316L					
	SBFT1125	WITH FAT	SS304	300x300	222	135	250	100
	SBFT1126	WITHOUT FAT	SS316L					
	SBFT1127	WITH FAT	SS304	300x300	222	160	250	100
	SBFT1128	WITHOUT FAT	SS316L					

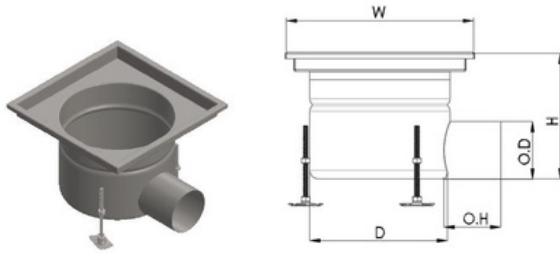

TYPE NO	PART NO	FAT	MOC	W	D	O.D	H	O.H
11286406	SBFT1129	WITH FAT	SS304	200x200	155	75	170	80
	SBFT1130	WITHOUT FAT	SS316L					
11286407	SBFT1131	WITH FAT	SS304	250x250	155	75	170	80
	SBFT1132	WITHOUT FAT	SS316L					
11286408	SBFT1133	WITH FAT	SS304	300x300	222	93	190	80
	SBFT1134	WITHOUT FAT	SS316L					

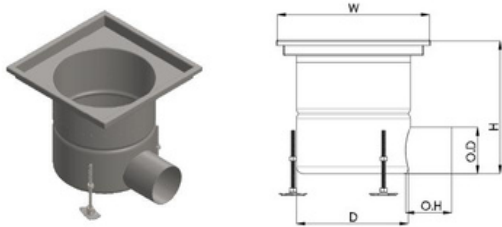

TYPE NO	PART NO	FAT	MOC	W	D	O.D	H	O.H
11286409	SBFT1135	WITH FAT	SS304	200x200	155	75	230	80
	SBFT1136	WITHOUT FAT	SS316L					
11286410	SBFT1137	WITH FAT	SS304	250x250	155	75	230	80
	SBFT1138	WITHOUT FAT	SS316L					
11286411	SBFT1139	WITH FAT	SS304	300x300	222	93	250	80
	SBFT1140	WITHOUT FAT	SS316L					

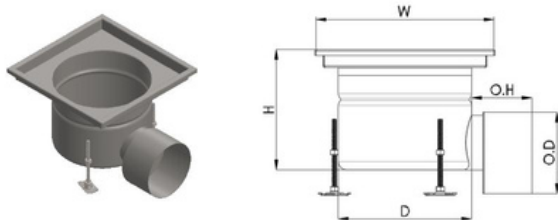

TYPE NO	PART NO	FAT	MOC	W	D	O.D	H	O.H
11286412	SBFT1141	WITH FAT	SS304	200x200	155	93	170	80
	SBFT1142	WITHOUT FAT	SS316L					
11286413	SBFT1143	WITH FAT	SS304	250x250	155	93	170	80
	SBFT1144	WITHOUT FAT	SS316L					
11286414	SBFT1145	WITH FAT	SS304	300x300	222	135	190	100
	SBFT1146	WITHOUT FAT	SS316L					
	SBFT1147	WITH FAT	SS304	300x300	222	160	190	100
	SBFT1148	WITHOUT FAT	SS316L					

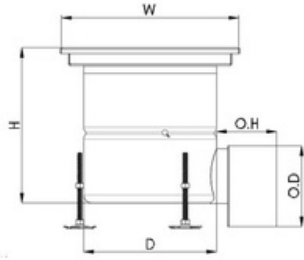

TYPE NO	PART NO	FAT	MOC	W	D	O.D	H	O.H
11286415	SBFT1149	WITH FAT	SS304	200x200	155	93	230	80
	SBFT1150	WITHOUT FAT	SS316L					
11286416	SBFT1151	WITH FAT	SS304	250x250	155	93	230	80
	SBFT1152	WITHOUT FAT	SS316L					
11286417	SBFT1153	WITH FAT	SS304	300x300	222	135	250	100
	SBFT1154	WITHOUT FAT	SS316L					
	SBFT1155	WITH FAT	SS304	300x300	222	160	250	100
	SBFT1156	WITHOUT FAT	SS316L					

STANDALONE ROUND

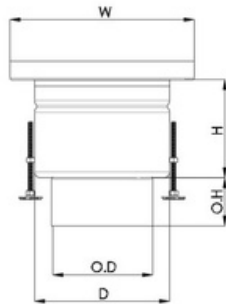

TYPE NO	PART NO	FAT	MOC	W	D	O.D	H	O.H
15011500	SBFT1201	WITH FAT	SS304	200	155	75	170	80
	SBFT1202	WITHOUT FAT	SS316L					
	SBFT1203	WITH FAT	SS304					
	SBFT1204	WITHOUT FAT	SS316L					
15011501	SBFT1205	WITH FAT	SS304	250	155	75	170	80
	SBFT1206	WITHOUT FAT	SS316L					
	SBFT1207	WITH FAT	SS304					
	SBFT1208	WITHOUT FAT	SS316L					
15011502	SBFT1209	WITH FAT	SS304	300	222	93	190	80
	SBFT1210	WITHOUT FAT	SS316L					
	SBFT1211	WITH FAT	SS304	300	222	135	190	100
	SBFT1212	WITHOUT FAT	SS316L					
	SBFT1213	WITH FAT	SS304	300	222	160	190	100
	SBFT1214	WITHOUT FAT	SS316L					

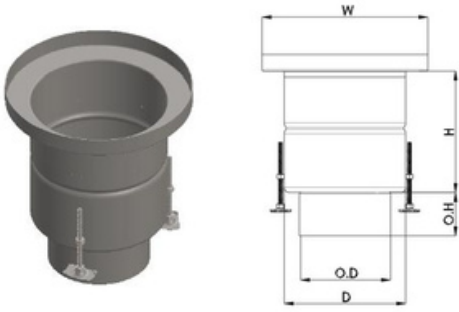

TYPE NO	PART NO	FAT	MOC	W	D	O.D	H	O.H
15011503	SBFT1215	WITH FAT	SS304	200	155	75	230	80
	SBFT1216	WITHOUT FAT	SS316L					
	SBFT1217	WITH FAT	SS304	200	155	93	230	80
	SBFT1218	WITHOUT FAT	SS316L					
15011504	SBFT1219	WITH FAT	SS304	250	155	75	230	80
	SBFT1220	WITHOUT FAT	SS316L					
	SBFT1221	WITH FAT	SS304	250	155	93	230	80
	SBFT1222	WITHOUT FAT	SS316L					
15011505	SBFT1223	WITH FAT	SS304	300	222	93	250	80
	SBFT1224	WITHOUT FAT	SS316L					
	SBFT1225	WITH FAT	SS304	300	222	135	250	100
	SBFT1226	WITHOUT FAT	SS316L					
	SBFT1227	WITH FAT	SS304	300	222	160	250	100
	SBFT1228	WITHOUT FAT	SS316L					

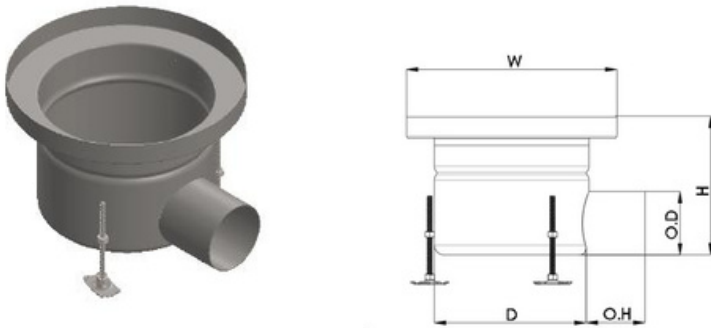

TYPE NO	PART NO	FAT	MOC	W	D	O.D	H	O.H
15011506	SBFT1229	WITH FAT	SS304	200	155	75	170	80
	SBFT1230	WITHOUT FAT	SS316L					
15011507	SBFT1231	WITH FAT	SS304	250	155	75	170	80
	SBFT1232	WITHOUT FAT	SS316L					
15011508	SBFT1233	WITH FAT	SS304	300	222	93	190	80
	SBFT1234	WITHOUT FAT	SS316L					

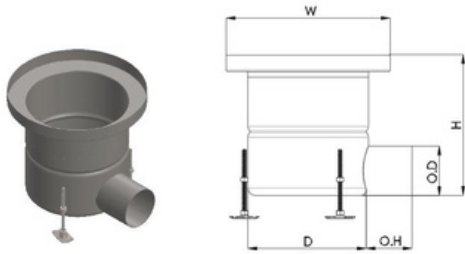

TYPE NO	PART NO	FAT	MOC	W	D	O.D	H	O.H
15011509	SBFT1235	WITH FAT	SS304	200	155	75	230	80
	SBFT1236	WITHOUT FAT	SS316L					
15011510	SBFT1237	WITH FAT	SS304	250	155	75	230	80
	SBFT1238	WITHOUT FAT	SS316L					
15011511	SBFT1239	WITH FAT	SS304	300	222	93	250	80
	SBFT1240	WITHOUT FAT	SS316L					

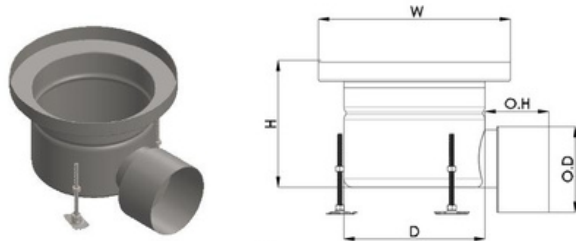

TYPE NO	PART NO	FAT	MOC	W	D	O.D	H	O.H
15011512	SBFT1241	WITH FAT	SS304	200	155	93	170	80
	SBFT1242	WITHOUT FAT	SS316L					
15011513	SBFT1243	WITH FAT	SS304	250	155	93	170	80
	SBFT1244	WITHOUT FAT	SS316L					
15011514	SBFT1245	WITH FAT	SS304	300	222	135	190	100
	SBFT1246	WITHOUT FAT	SS316L					
	SBFT1247	WITH FAT	SS304	300	222	160	190	100
	SBFT1248	WITHOUT FAT	SS316L					

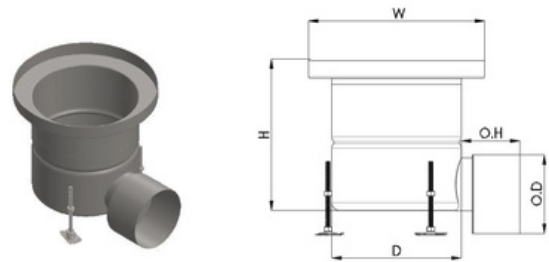

TYPE NO	PART NO	FAT	MOC	W	D	O.D	H	O.H
15011515	SBFT1249	WITH FAT	SS304	200	155	93	230	80
	SBFT1250	WITHOUT FAT	SS316L					
15011516	SBFT1251	WITH FAT	SS304	250	155	93	230	80
	SBFT1252	WITHOUT FAT	SS316L					
15011517	SBFT1253	WITH FAT	SS304	300	222	135	250	100
	SBFT1254	WITHOUT FAT	SS316L					
	SBFT1255	WITH FAT	SS304	300	222	160	250	100
			SS316L					

WITH MEMBRANE SQUARE

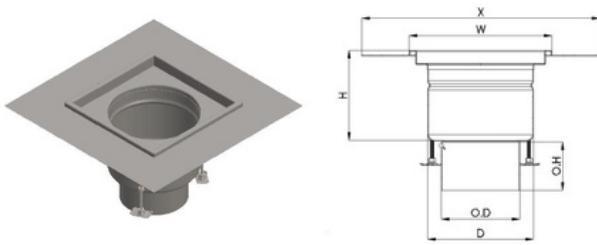

TYPE NO	PART NO	FAT	MOC	W	D	O.D	H	O.H	X
19062000	SBFT1401	WITH FAT	SS304	200x200	155	75	170	80	400
	SBFT1402	WITHOUT FAT	SS316L						
	SBFT1403	WITH FAT	SS304	200x200	155	93	170	80	400
	SBFT1404	WITHOUT FAT	SS316L						
19062001	SBFT1405	WITH FAT	SS304	250x250	155	75	170	80	450
	SBFT1406	WITHOUT FAT	SS316L						
	SBFT1407	WITH FAT	SS304	250x250	155	93	170	80	450
	SBFT1408	WITHOUT FAT	SS316L						
19062002	SBFT1409	WITH FAT	SS304	300x300	222	93	190	80	500
	SBFT1410	WITHOUT FAT	SS316L						
	SBFT1411	WITH FAT	SS304	300x300	222	135	190	100	500
	SBFT1412	WITHOUT FAT	SS316L						
	SBFT1413	WITH FAT	SS304	300x300	222	160	190	100	500
	SBFT1414	WITHOUT FAT	SS316L						

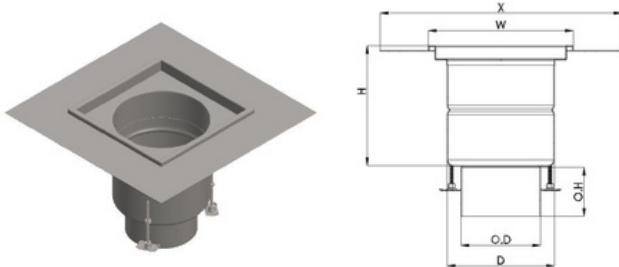

TYPE NO	PART NO	FAT	MOC	W	D	O.D	H	O.H	X
19062003	SBFT1415	WITH FAT	SS304	200x200	155	75	230	80	400
	SBFT1416	WITHOUT FAT	SS316L						
	SBFT1417	WITH FAT	SS304	200x200	155	93	230	80	400
	SBFT1418	WITHOUT FAT	SS316L						
19062004	SBFT1419	WITH FAT	SS304	250x250	155	75	230	80	450
	SBFT1420	WITHOUT FAT	SS316L						
	SBFT1421	WITH FAT	SS304	250x250	155	93	230	80	450
	SBFT1422	WITHOUT FAT	SS316L						
19062005	SBFT1423	WITH FAT	SS304	300x300	222	93	250	80	500
	SBFT1424	WITHOUT FAT	SS316L						
	SBFT1425	WITH FAT	SS304	300x300	222	135	250	100	500
	SBFT1426	WITHOUT FAT	SS316L						
	SBFT1427	WITH FAT	SS304	300x300	222	160	250	100	500
	SBFT1428	WITHOUT FAT	SS316L						

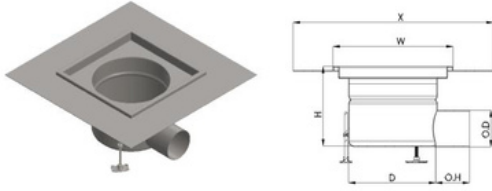

TYPE NO	PART NO	FAT	MOC	W	D	O.D	H	O.H	X
19062006	SBFT1429	WITH FAT	SS304	200x200	155	75	170	80	400
	SBFT1430	WITHOUT FAT	SS316L						
19062007	SBFT1431	WITH FAT	SS304	250x250	155	75	170	80	450
	SBFT1432	WITHOUT FAT	SS316L						
19062008	SBFT1433	WITH FAT	SS304	300x300	222	93	190	80	500
	SBFT1434	WITHOUT FAT	SS316L						

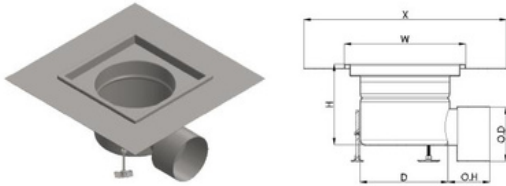

TYPE NO	PART NO	FAT	MOC	W	D	O.D	H	O.H	X
19062009	SBFT1435	WITH FAT	SS304	200x200	155	93	170	80	400
	SBFT1436	WITHOUT FAT	SS316L						
19062010	SBFT1437	WITH FAT	SS304	250x250	155	75	170	80	450
	SBFT1438	WITHOUT FAT	SS316L						
19062011	SBFT1439	WITH FAT	SS304	300x300	222	135	190	100	500
	SBFT1440	WITHOUT FAT	SS316L						
	SBFT1441	WITH FAT	SS304	300x300	222	160	190	100	500
	SBFT1442	WITHOUT FAT	SS316L						

FOR VINYL FLOORS

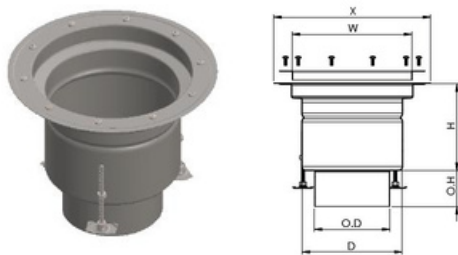

TYPE NO	PART NO	FAT	MOC	W	D	O.D	H	O.H	X
27059300	SBFT1801	WITH FAT	SS304	210	155	75	170	80	410
	SBFT1802	WITHOUT FAT	SS316L						
	SBFT1803	WITH FAT	SS304	210	155	93	170	80	410
	SBFT1804	WITHOUT FAT	SS316L						

27059301	SBFT1805	WITH FAT	SS304	270	222	93	190	80	470
	SBFT1806	WITHOUT FAT	SS316L						
	SBFT1807	WITH FAT	SS304	270	222	135	190	100	470
	SBFT1808	WITHOUT FAT	SS316L						
	SBFT1809	WITH FAT	SS304	270	222	160	190	100	470
	SBFT1810	WITHOUT FAT	SS316L						

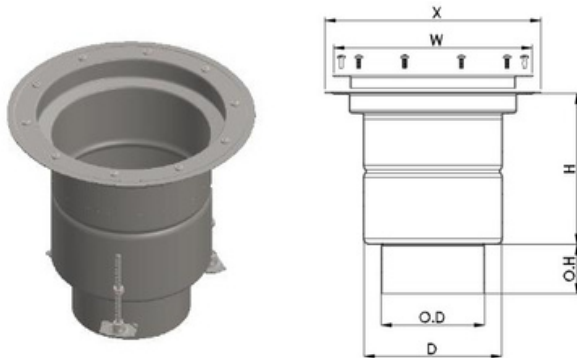

TYPE NO	PART NO	FAT	MOC	W	D	O.D	H	O.H	X
27059302	SBFT1811	WITH FAT	SS304	210	155	75	230	80	410
	SBFT1812	WITHOUT FAT	SS316L						
	SBFT1813	WITH FAT	SS304	210	155	93	230	80	410
	SBFT1814	WITHOUT FAT	SS316L						
27059303	SBFT1815	WITH FAT	SS304	270	222	93	250	80	470
	SBFT1816	WITHOUT FAT	SS316L						
	SBFT1817	WITH FAT	SS304	270	222	135	250	100	470
	SBFT1818	WITHOUT FAT	SS316L						
	SBFT1819	WITH FAT	SS304	270	222	160	250	100	470
	SBFT1820	WITHOUT FAT	SS316L						

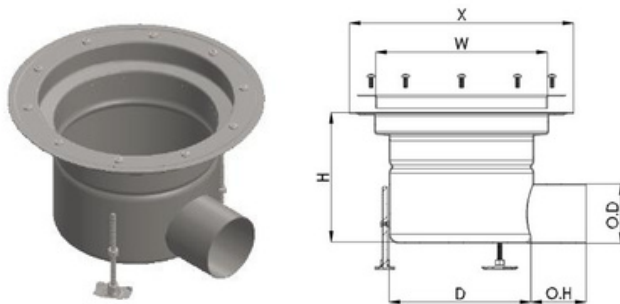

TYPE NO	PART NO	FAT	MOC	W	D	O.D	H	O.H	X
27059304	SBFT1821	WITH FAT	SS304	210	155	75	170	80	410
	SBFT1822	WITHOUT FAT	SS316L						
27059305	SBFT1823	WITH FAT	SS304	270	222	93	190	80	470
	SBFT1824	WITHOUT FAT	SS316L						

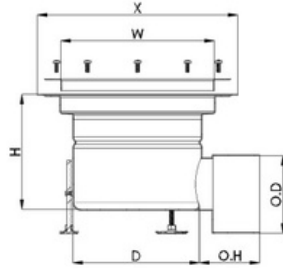

TYPE NO	PART NO	FAT	MOC	W	D	O.D	H	O.H	X
27059306	SBFT1825	WITH FAT	SS304	210	155	93	170	80	410
	SBFT1826	WITHOUT FAT	SS316L						
27059307	SBFT1827	WITH FAT	SS304	270	222	135	190	100	470
	SBFT1828	WITHOUT FAT	SS316L						
	SBFT1829	WITH FAT	SS304						
	SBFT1830	WITHOUT FAT	SS316L						

**GRATINGS SQUARE
PLATE WITH SLOT**

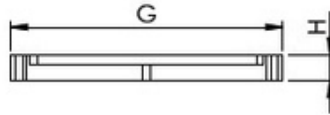
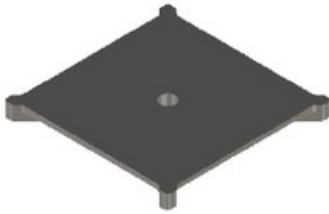

TYPE NO	PART NO	MOC	G	H	LOAD
12089800	SBFT2101	SS304-SS316L	168x168	20	M125
	SBFT2102	SS304-SS316L	218x218	23	M125
	SBFT2103	SS304-SS316L	268x268	28	M125

PLATE WITH SLOTS



TYPE NO	PART NO	MOC	G	H	LOAD
12089801	SBFT2104	SS304-SS316L	168x168	20	L15
	SBFT2105	SS304-SS316L	218x218	23	L15
	SBFT2106	SS304-SS316L	268x268	28	L15

ANTISLIP MESH

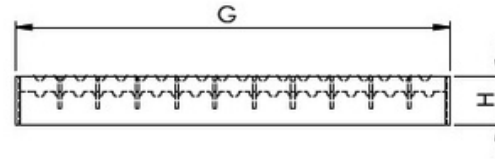
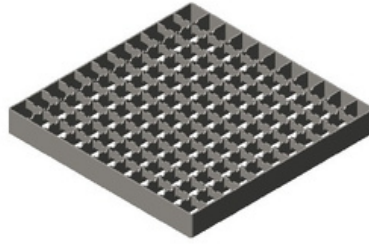

TYPE NO	PART NO	MOC	G	H	LOAD
12089802	SBFT2107	SS304-SS316L	168x168	20	M125
	SBFT2108	SS304-SS316L	218x218	23	M125
	SBFT2109	SS304-SS316L	268x268	28	M125

ANTISLIP MESH EXTRUDED

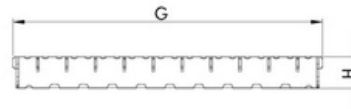
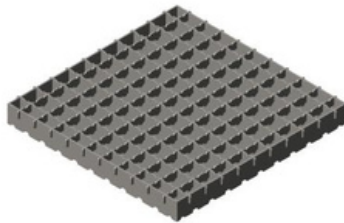

TYPE NO	PART NO	MOC	G	H	LOAD
12089803	SBFT2110	SS304-SS316L	168x168	20	L15
	SBFT2111	SS304-SS316L	218x218	23	L15
	SBFT2112	SS304-SS316L	268x268	28	L15

LADDER TYPE

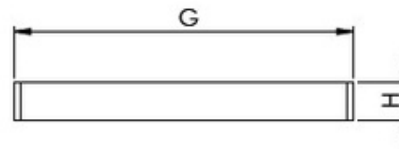
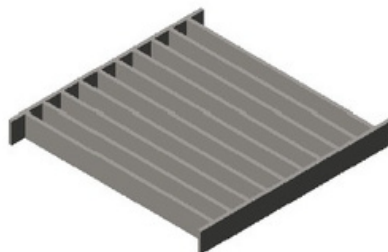

TYPE NO	PART NO	MOC	G	H	LOAD
12089807	SBFT2122	SS304-SS316L	168x168	20	C250
	SBFT2123	SS304-SS316L	218x218	23	C250
	SBFT2124	SS304-SS316L	268x268	28	C250

**GRATINGS ROUND
PLATE WITH SLOT**

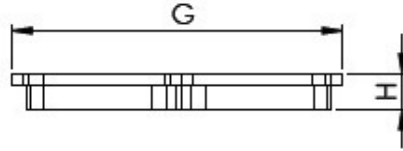

TYPE NO	PART NO	MOC	G	H	LOAD
12089808	SBFT2125	SS304-SS316L	168	20	M125
	SBFT2126	SS304-SS316L	218	23	M125
	SBFT2127	SS304-SS316L	268	28	M125

PLATE WITH SLOTS

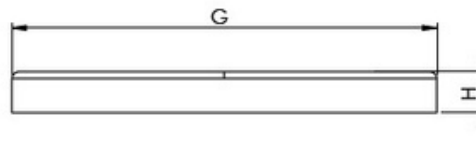

TYPE NO	PART NO	MOC	G	H	LOAD
12089809	SBFT2128	SS304-SS316L	168	20	L15
	SBFT2129	SS304-SS316L	218	23	L15
	SBFT2130	SS304-SS316L	268	28	L15

MESH WITH ANTISLIP

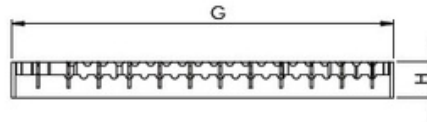

TYPE NO	PART NO	MOC	G	H	LOAD
12089810	SBFT2131	SS304-SS316L	168	20	L15
	SBFT2132	SS304-SS316L	218	23	L15
	SBFT2133	SS304-SS316L	268	28	L15

LADDER TYPE

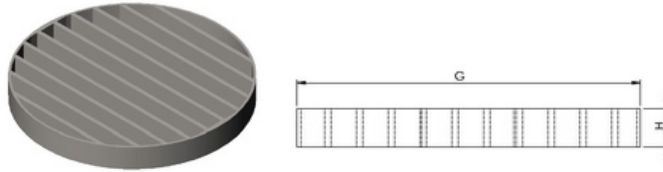

TYPE NO	PART NO	MOC	G	H	LOAD
12089812	SBFT2137	SS304-SS316L	168	20	C250
	SBFT2138	SS304-SS316L	218	23	C250
	SBFT2139	SS304-SS316L	268	28	C250

ACCESSORIES

SILT BASKET



TYPE NO	PART NO	MOC	D	H
28129400	SBFT3001	SS304-SS316L	230	25
	SBFT3002	SS304-SS316L	160	25

FOUL AIR TRAP (FAT)

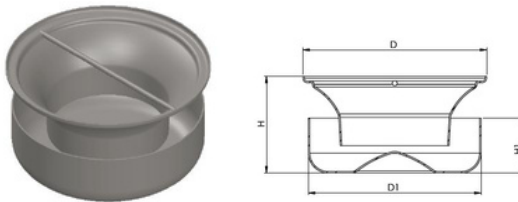

TYPE NO	PART NO	MOC	D	D1	H	H
28129401	SBFT3101	SS304-SS316L	126	106	70	70
	SBFT3102	SS304-SS316L	183	170	90	90

FAT GASKET

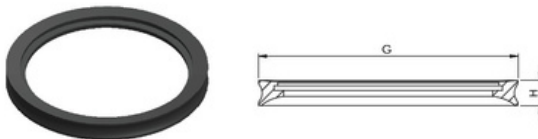

TYPE NO	PART NO	MOC	D	H
28129402	SBFT3202	SS304-SS316L	155	19
	SBFT3202	SS304-SS316L	218	21

CHANNEL DRAINS

BOX CHANNEL RADIUS END

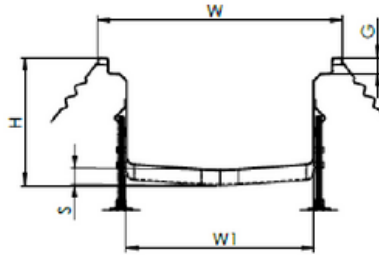

TYPE NO	PART NO	MOC	W	W1	H	S	G
33034800	SBFT5001	SS304-SS316L	200	140	80-300	1:80 to 1:200	20
	SBFT5002	SS304-SS316L	250	190	80-375	1:80 to 1:200	20
	SBFT5003	SS304-SS316L	300	240	80-375	1:80 to 1:200	20 to 30
	SBFT5004	SS304-SS316L	350	290	80-350	1:80 to 1:200	20 to 30
	SBFT5005	SS304-SS316L	400	340	80-300	1:80 to 1:200	20 to 30

Length and shape depends upon the site.

OPEN MEMBRANE

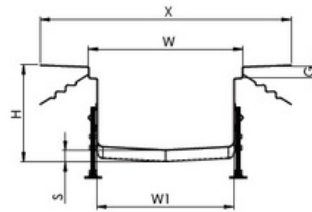

TYPE NO	PART NO	MOC	W	W1	H	S	G	X
33034802	SBFT5201	SS304-SS316L	200	140	80-300	1:80 to 1:200	20	400
	SBFT5202	SS304-SS316L	250	190	80-375	1:80 to 1:200	20	450
	SBFT5203	SS304-SS316L	300	240	80-375	1:80 to 1:200	20 to 30	500
	SBFT5204	SS304-SS316L	350	290	80-350	1:80 to 1:200	20 to 30	550
	SBFT5205	SS304-SS316L	400	340	80-300	1:80 to 1:200	20 to 30	600

Length and shape depends upon the site.

VINYL FLOOR CHANNEL

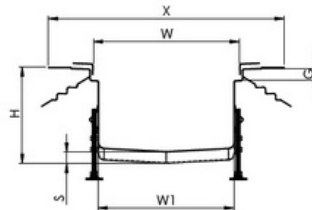

TYPE NO	PART NO	MOC	W	W1	H	S	G	X
33034806	SBFT5601	SS304-SS316L	200	140	80-300	1:80 to 1:200	20	400
	SBFT5602	SS304-SS316L	250	190	80-375	1:80 to 1:200	20	450
	SBFT5603	SS304-SS316L	300	240	80-375	1:80 to 1:200	20 to 30	500
	SBFT5604	SS304-SS316L	350	290	80-350	1:80 to 1:200	20 to 30	550
	SBFT5605	SS304-SS316L	400	340	80-300	1:80 to 1:200	20 to 30	600

Length and shape depends upon the site.

DPC SEEPAGE HOLES CHANNEL

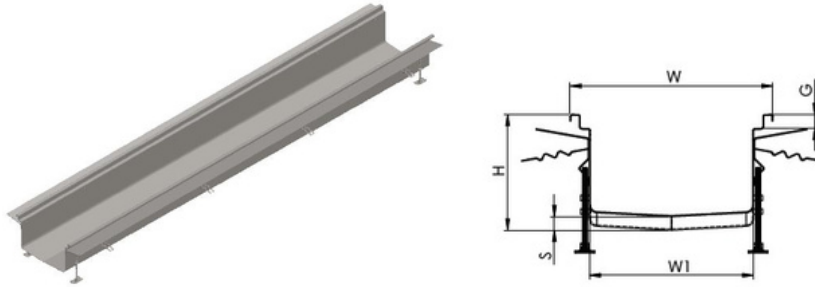

TYPE NO	PART NO	MOC	W	W1	H	S	G
33034807	SBFT5701	SS304-SS316L	200	140	80-300	1:80 to 1:200	20
	SBFT5702	SS304-SS316L	250	190	80-375	1:80 to 1:200	20
	SBFT5703	SS304-SS316L	300	240	80-375	1:80 to 1:200	20 to 30
	SBFT5704	SS304-SS316L	350	290	80-350	1:80 to 1:200	20 to 30
	SBFT5705	SS304-SS316L	400	340	80-300	1:80 to 1:200	20 to 30

Length and shape depends upon the site.

SMALL GRATE CHANNEL

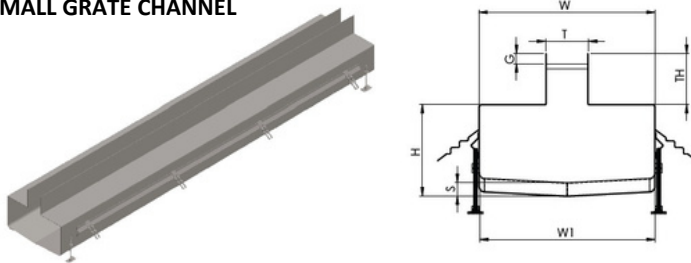

TYPE NO	PART NO	MOC	W	W1	H	S	T	T.H
33034808	SBFT5801	SS304-SS316L	200	200	80-300	1:80 to 1:200	80	100
	SBFT5802	SS304-SS316L	250	250	80-375	1:80 to 1:200	80	100
	SBFT5803	SS304-SS316L	300	300	80-375	1:80 to 1:200	80	100
	SBFT5804	SS304-SS316L	350	350	80-350	1:80 to 1:200	80	100
	SBFT5805	SS304-SS316L	400	400	80-300	1:80 to 1:200	80	100

Length, shape and throat height depends upon the site.

SLOT or STRIP CHANNEL

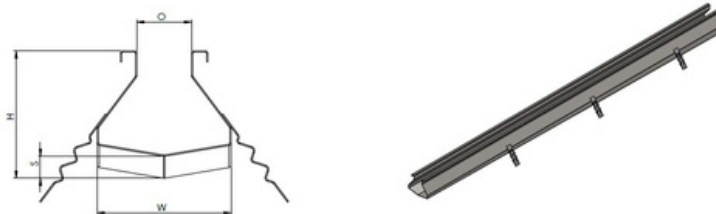

TYPE NO	PART NO	MOC	W	H	S	O
33034809	SBFT5901	SS304-SS316L	100	80-120	1:80 to 1:200	30
	SBFT5402	SS304-SS316L	120	80-375	1:80 to 1:200	30

Length, shape and throat opening depends upon the site.

**CHANNEL GRATINGS
MESH GRATING WITH ANTISLIP**

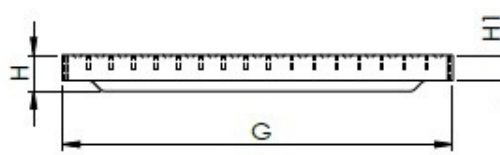
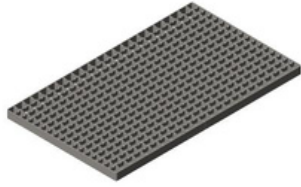

TYPE NO	PART NO	MOC	G	H	H1	LOAD
35110800	SBFT6001	SS304-SS316L	499x168	30	20	M125
	SBFT6002	SS304-SS316L	499x 218	30	20	M125
	SBFT6003	SS304-SS316L	499x 268	30	20	M125
	SBFT6004	SS304-SS316L	499x 318	30	20	M125
	SBFT6005	SS304-SS316L	499x 368	30	20	M125

MESH GRATING WITH ANTISLIP

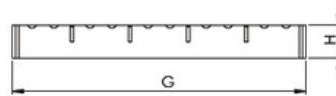
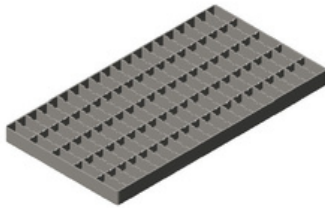

TYPE NO	PART NO	MOC	G	H	LOAD
35110801	SBFT6101	SS304-SS316L	499x168	30	C250
	SBFT6102	SS304-SS316L	499x 218	30	C250
	SBFT6103	SS304-SS316L	499x 268	30	C250
	SBFT6104	SS304-SS316L	499x 318	30	C250
	SBFT6105	SS304-SS316L	499x 368	30	C250

LADDER TYPE

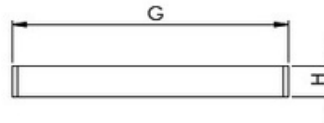
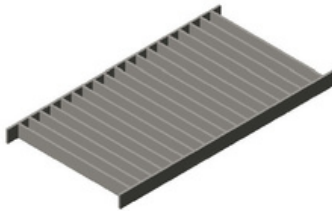

TYPE NO	PART NO	MOC	G	H	LOAD
35110806	SBFT6601	SS304-SS316L	499x168	30	C250
	SBFT6602	SS304-SS316L	499x 218	30	C250
	SBFT6603	SS304-SS316L	499x 268	30	C250
	SBFT6604	SS304-SS316L	499x 318	30	C250
	SBFT6605	SS304-SS316L	499x 368	30	C250

SHEET WITH SQUARE SLOTS

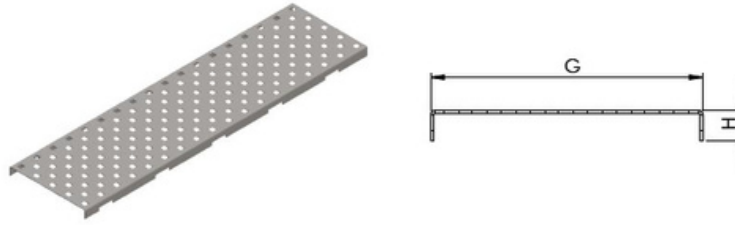

TYPE NO	PART NO	MOC	G	H	LOAD
35110807	SBFT6701	SS304-SS316L	499x168	20	L15
	SBFT6702	SS304-SS316L	499x 218	20	L15
	SBFT6703	SS304-SS316L	499x 268	20	L15
	SBFT6704	SS304-SS316L	499x 318	20	L15
	SBFT6705	SS304-SS316L	499x 368	20	L15

BOX CHANNELS

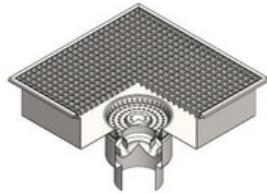

TYPE NO	PART NO	MOC	L	W	H
40812000	SBFT7001	SS304-SS316L	400	400	100-250
	SBFT7001	SS304-SS316L	500	500	100-250
	SBFT7001	SS304-SS316L	600	600	100-250
	SBFT7001	SS304-SS316L	800	800	100-250
40812001	SBFT7001	SS304-SS316L	400	300	100-250
	SBFT7001	SS304-SS316L	500	700	100-250
	SBFT7001	SS304-SS316L	600	400	100-250
	SBFT7001	SS304-SS316L	800	500	100-250

Total depth depends upon the gully, Grating depends upon the box size.

HIGH FLOW DRAINS

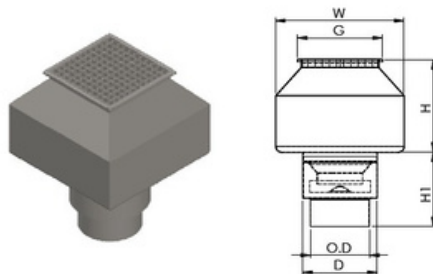

TYPE NO	PART NO	MOC	w	G	D	O.D	H	H1
40812102	SBFT7101	SS304-SS316L	450	300	260	135-200	200-350	260-320

Total depth depends upon the gully.

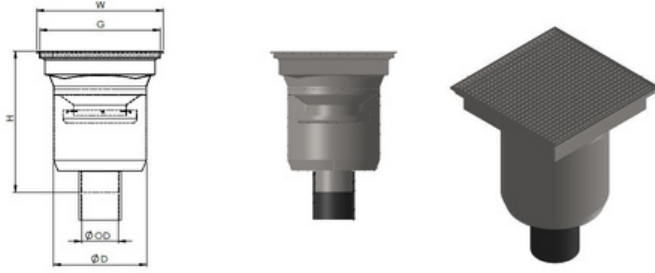

TYPE NO	PART NO	MOC	w	G	D	O.D	H
40812103	SBFT7102	SS304-SS316L	430x430	400	310	135-200	500-750
40812104	SBFT7103	SS304-SS316L	600x600	570	440	135-200	500-750

BOX WITH CHANNELS

TYPE NO	40812103
PART NO	SBFT7201
MOC	SS304-SS316L
LENGHT	2.6, 3, 4, 5 and 6m
WIDTH	200, 250,300,350 and 400mm
HEIGHT	Depends upon channel box and gully.
GULLY	Vertical and Horizontal

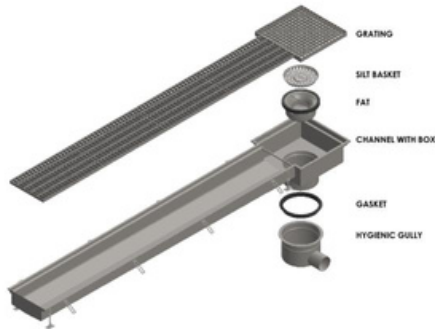

TYPE NO	40812104
PART NO	SBFT7301
MOC	SS304-SS316L
LENGHT	2.6, 3, 4, 5 and 6m
WIDHT OF BOX	200, 250,300,350 and 400mm
HEIGHT	Depends upon box and gully.
GULLY	Vertical and Horizontal

PHARMA DRAINS
ECLIPSE TYPE

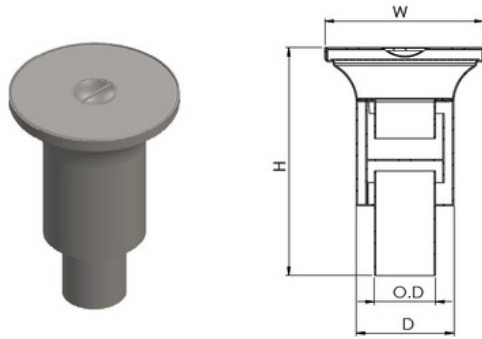

TYPE NO	PART NO	MOC	W	D	H	O.D
45106400	SBFT8001	SS304-SS316L	184	100	250	60
	SBFT8002	SS304-SS316L	184	120	250	80

ECLIPSE TYPE WITH BED

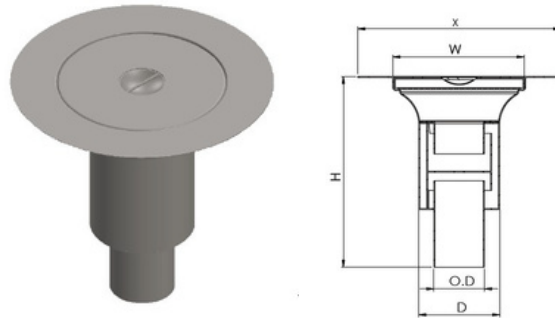

TYPE NO	PART NO	MOC	W	D	H	O.D	X
45106401	SBFT8101	SS304-SS316L	184	100	250	60	300
	SBFT8102	SS304-SS316L	184	120	250	80	300

ECLIPSE ANTISLIP WITH BED

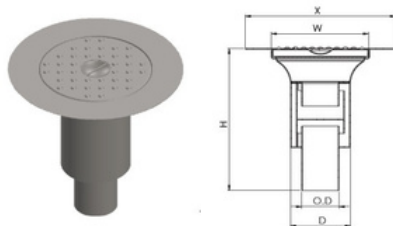

TYPE NO	PART NO	MOC	W	D	H	O.D	X
45106402	SBFT8201	SS304-SS316L	184	100	250	60	300
	SBFT8202	SS304-SS316L	184	120	250	80	300

HYGIENIC ROUND

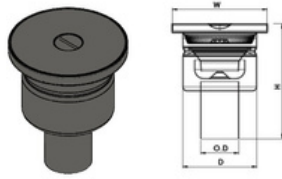

TYPE NO	PART NO	MOC	W	D	H	O.D
45106403	SBFT8301	SS304-SS316L	180	155	250	80
	SBFT8302	SS304-SS316L	200	155	250	100

HYGIENIC SQUARE WITH SIDE PIPE JOINTS

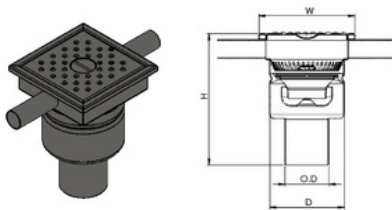

TYPE NO	PART NO	MOC	W	D	H	O.D
45106404	SBFT8401	SS304-SS316L	200x200	155	250	80
	SBFT8402	SS304-SS316L	200x200	155	250	100

SQUARE PLAIN

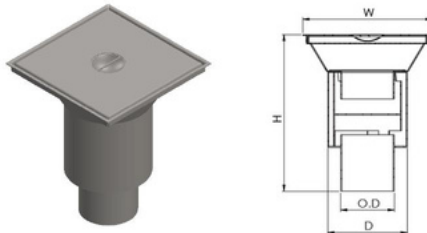

TYPE NO	PART NO	MOC	W	D	H	O.D
45106405	SBFT8501	SS304-SS316L	180x180	125	250	80
	SBFT8502	SS304-SS316L	200x200	145	250	100

SQUARE WITH PIPE JOINT

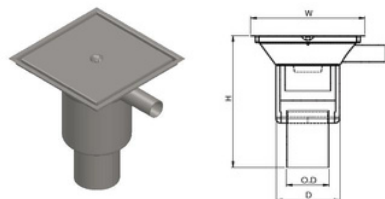

TYPE NO	PART NO	MOC	W	D	H	O.D
45106405	SBFT8501	SS304-SS316L	180x180	125	250	80
	SBFT8502	SS304-SS316L	200x200	145	250	100



+91 98803 33302



Shakti@sribal.in



Corporate Office : No 662, 16th Main, Narayana
Nagar, 1st Block Doddakallasandra, Bengaluru,
Karnataka, India, 560062